

designwerk
Vola



Model: Vola element 105 armrest left + element 70 + REC armrest right + megastool
Cover: leather Eagle M2102 Grey

VOLA

Details



French seam as an eye-catcher



Wide seats



Wing-like armrests

– Tantalisingly charming: You can't help but love Vola. Wide seats paired with wing-like armrests provide an elegant finish, giving the sofa a level of flamboyance. Finished with exquisite fabrics or high-quality leather and decorative reverse stitching, this sofa will bring new accents to your living room. Colour-coordinated accessories complete a harmonious look. –

VOLA

Technical data

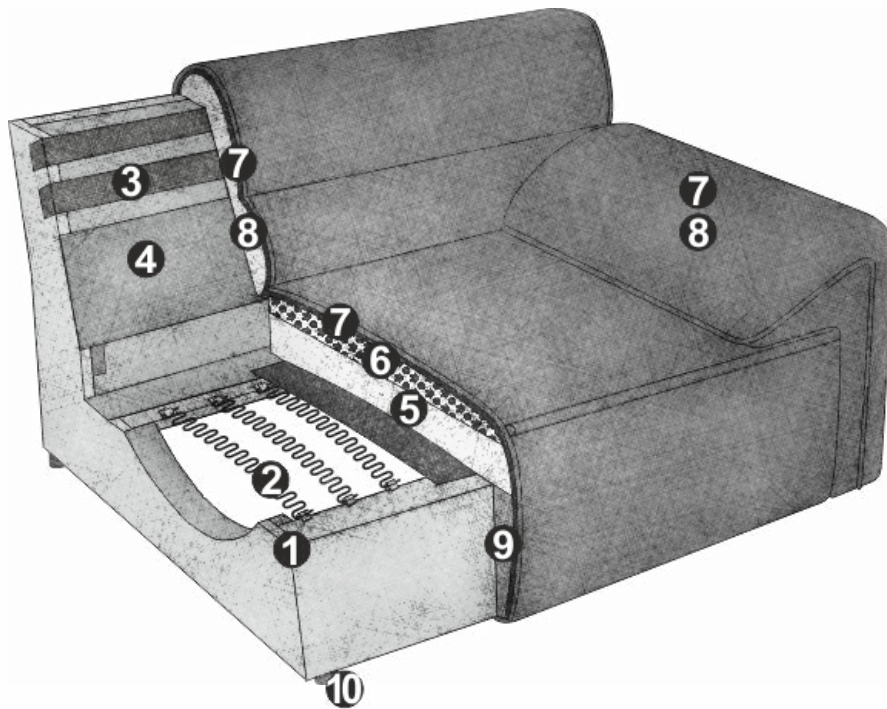

- 01** Frame: Beech wooden construction
- 02** Seat suspension: permanently elastic Nosag steel wave springs with felt cover
- 03** Back suspension: flexible upholstery straps
- 04** Back suspension: padded cardboard
- 05** Upholstery structure seat: highly elastic cold foam (density 35 kg/m³)
- 06** Upholstery structure seat: chamber cushion with a filling of viscose foam flakes (70%) and silicone fibres (30%)
- 07** Upholstery structure back, seat and armrest: upholstery wadding 300g
- 08** Upholstery structure back and armrest: highly elastic cold foam (density 25 kg/m³)
- 09** Upholstery structure of front panel: standard comfort foam (density 25 kg/m³)
- 10** Foot: plastic base

Good to know:

- available in fabric and leather (single colour)
- includes easyjack connector system for maximum flexibility
- FSC® certified (FSC®-C112933)
- optional accessories: kidney cushions, throw cushions

VOLA

Type plan



Decorative cushions are available in a wealth of designs and upholstery options.
Find out more at www.designwerk.li

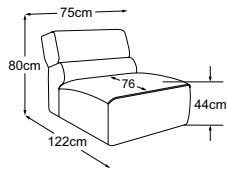

Element 70 without armrest
Item number: D009118

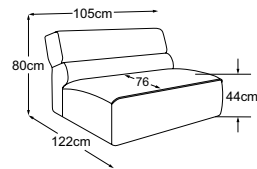

Element 105 without armrest
Item number: D009119

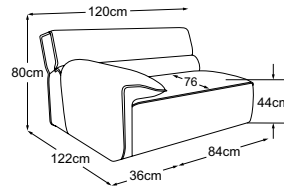

Element 105 armrest left
Item number: D009105

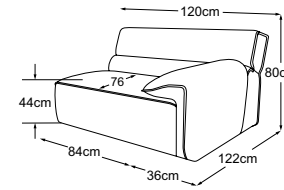

Element 105 armrest right
Item number: D009106

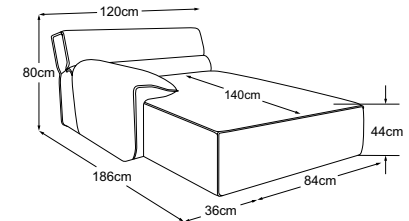

REC left
Item number: D009121

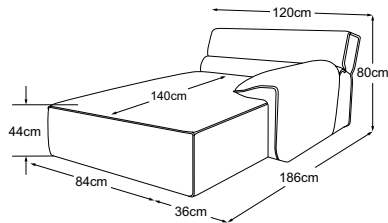

REC right
Item number: D009122

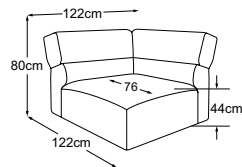

Corner
Item number: D009519

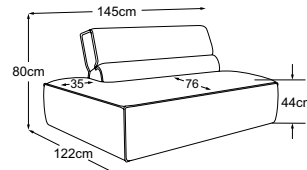

2HT left
Item number: D009520

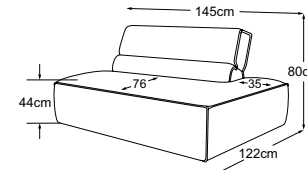

2HT right
Item number: D009521

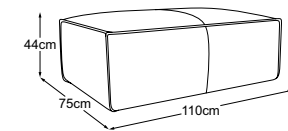

Megastool
Item number: D009805

Foot available in:



B: matt black

Please specify foot variant on order.

VOLA

Connection logic



The following elements can be connected to each other:

		D009105	D009106	D009118	D009119	D009121	D009122	D009519	D009520	D009521
Element 105 armrest left	D009105		X	X	X		X	X		X
Element 105 armrest right	D009106	X		X	X	X		X	X	
Element 70 without armrest	D009118	X	X	X	X	X	X	X	X	X
Element 105 without armrest	D009119	X	X	X	X	X	X	X	X	X
REC left	D009121		X	X	X				X	
REC right	D009122	X		X	X				X	
Corner	D009519	X	X	X	X				X	X
2HT left	D009520		X	X	X		X	X		X
2HT right	D009521	X		X	X	X		X	X	

The individual elements can be quickly and easily connected using the easyjack connector system. Scan the QR code for more information:



VOLA

Impressions





www.designwerk.li